

Description

Q-Tech's high-temperature crystal oscillators consist of a source clock square wave generator, logic output buffers and/or logic divider stages, and a round AT or IT-cut high-precision quartz crystal built in a wide selection of Dual-In-Line (DIP), Surface-Mount (SMD), or 7 x 5mm leaded or Surface-Mount (SMD) hermetically sealed packages.

Features

- Made in the USA
- ECCN: EAR99
- DFARS 252-225-7014 Compliant:
Electronic Component Exemption
- USML Registration # M17677
- Wide frequency range from 1Hz to 110MHz
- Wide operating temperature range -55°C to +225°C
- Choice of output logic options (CMOS, ACмос, HCMOS, LVHCMOS, TTL, Sine, and Z outputs)
- Supply voltages from 3.3Vdc to 15Vdc
- Hermetically sealed package
- Tight or custom symmetry available
- Fast start-up time
- Capacitive load drive capability (Z output)
- Multiple outputs available
- Fundamental and third overtone designs
- 100% testing including at extreme temperatures
- A custom MCM part number will be assigned to each specific customer's application
- Q-Tech does not use pure lead or pure tin in its products
- RoHS compliant



Applications

- Designed to meet today's requirements for all industries requiring high-temperature applications of electronic circuits beyond +125°C
- Oil service industry
- Gas turbine controls
- Measurement while drilling, data-logging tools
- Industrial controls
- High-temperature switching power supplies modules

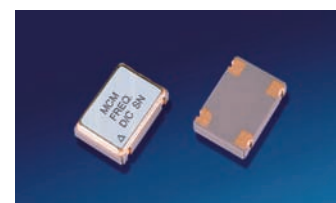
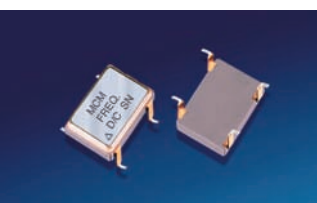
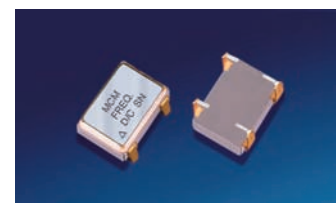
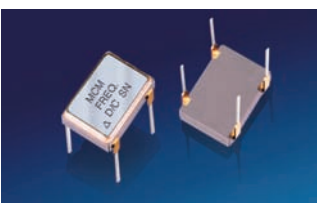
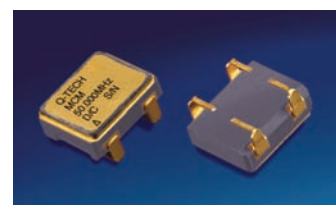
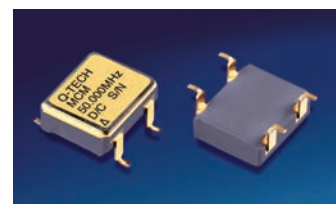
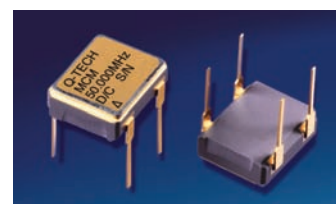
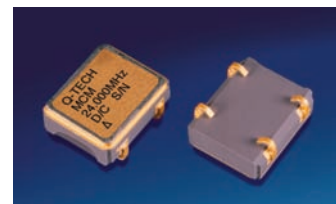
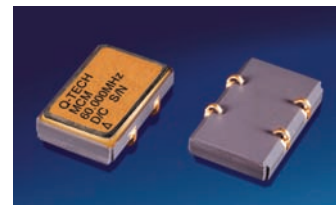

Part Numbering System

Q-Tech Corporation assigns a custom MCM part number for each of the customer's specification or application. The unique part numbering system allows Q-Tech to design, select appropriate technology (packaging, supply current, operating temperature, vibration and shock requirement, etc.) to tailor customer's specific needs. The part is available in standard Full Military screening (-M) per MIL-PRF-55310, product level B. Sample part number MCM7933-3M

Technology

Package and Frequency

5.0V		3.3V	
DIP-14:	1Hz to 110MHz	DIP-14:	1Hz to 70MHz
DIP-8:	1Hz to 85MHz	DIP-8:	1Hz to 70MHz
TO-5:	10kHz to 85MHz	TO-5:	10kHz to 70MHz
SMD:	15kHz to 85MHz	SMD:	15kHz to 70MHz
7x5mm	500kHz to 40MHz	7x5mm	500kHz to 40MHz

Logic

CMOS, ACNOS, HCMOS, LVHCMOS, TTL, SINE

Supply Voltage

Standard 3.3Vdc and 5Vdc $\pm 10\%$

Available in lower and higher voltages 2.5Vdc to 18Vdc

Supply Current

Q-Tech high-temperature crystal oscillators were designed to assure low power consumption.

Standard typical no load supply current on high-temperature oscillators:

QT50L8M-10kHz	2.0mA	(Custom design to 0.8mA)
QT78L8M-32.768kHz	2.5mA	
QT50L8-32.768kHz	2.0mA	(Custom design to 1.0mA)
QT4C8M-290kHz	5mA	at 10Vdc
QT50HC8-4.096MHz	2mA	
QT6C8M-4.194MHz	2.2mA	
QT89L8-12MHz	5mA	
QT89L8M-16MHz	6mA	
QT75L8M-20MHz	6mA	
QT89L8M-24MHz	6mA	
QT89L8M-32MHz	11mA	
QT89AC8-32MHz	12mA	
QT50HC8M-40MHz	12mA	
QT6HC8M-44MHz	25mA	
QT89L8-48MHz	15mA	
QT50HC8-64MHz	30mA	

Symmetry

45/55% max. for $F_o < 12\text{MHz}$

40/60% max. for $F_o \geq 12\text{MHz}$

Operating Temperature

Q-Tech extends its product offering to a wide operating temperature range from -55°C to $+225^\circ\text{C}$.

Frequency Stability

Operating temperature and frequency dependent
Standard offerings:

0°C to $+150^\circ\text{C}$ $\pm 150\text{ppm}$, $\pm 200\text{ppm}$, $\pm 250\text{ppm}$

0°C to $+175^\circ\text{C}$ $\pm 200\text{ppm}$, $\pm 250\text{ppm}$

0°C to $+200^\circ\text{C}$ $\pm 250\text{ppm}$

0°C to $+225^\circ\text{C}$ $\pm 450\text{ppm}$

Offering as low as $\pm 75\text{ppm}$. Please contact Q-Tech for details.

Materials

- Standard Al_2O_3 thick-film substrate
- Standard Gold (Au) and Aluminum (Al) wire bonding
- High-temperature non-conductive or Ag conductive epoxies
- Round or strip AT-Cut Fundamental or Third-Overtone quartz crystals
- Standard design for crystal mounting for high-shock (up to 36,000g on QT78, 88, 89 and 7 x 5mm with crystal frequencies to 24MHz)
- CMOS, HCMOS, LVHCMOS Oscillator IC or discrete semiconductor used

Options

- Screening to MIL-PRF-55310
- Tri-state Output (May not be available in certain low frequencies and package types)
- Multiple Outputs
- Phase Locked Output
- Low Voltage / Low Current
- Voltage Control (VCXO / VCO)
- Hybridize customer's designs

Please contact our factory or visit our website, www.q-tech.com for technical updates.

Package Configuration Versus Pin Connections

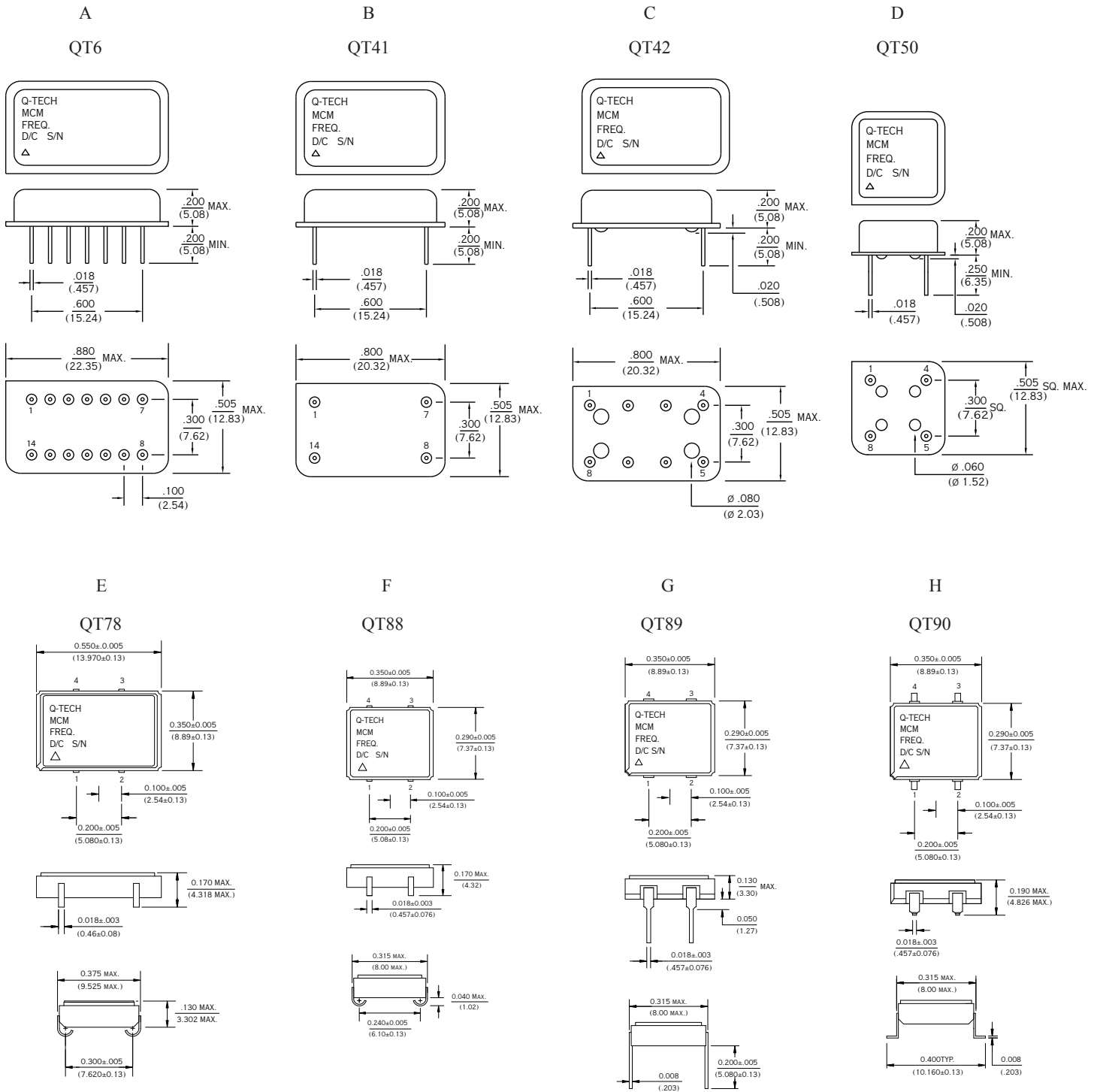

Dimensions are in inches (mm)

Package Configuration Versus Pin Connections (Cont'd)

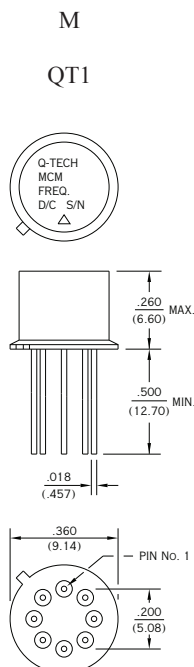
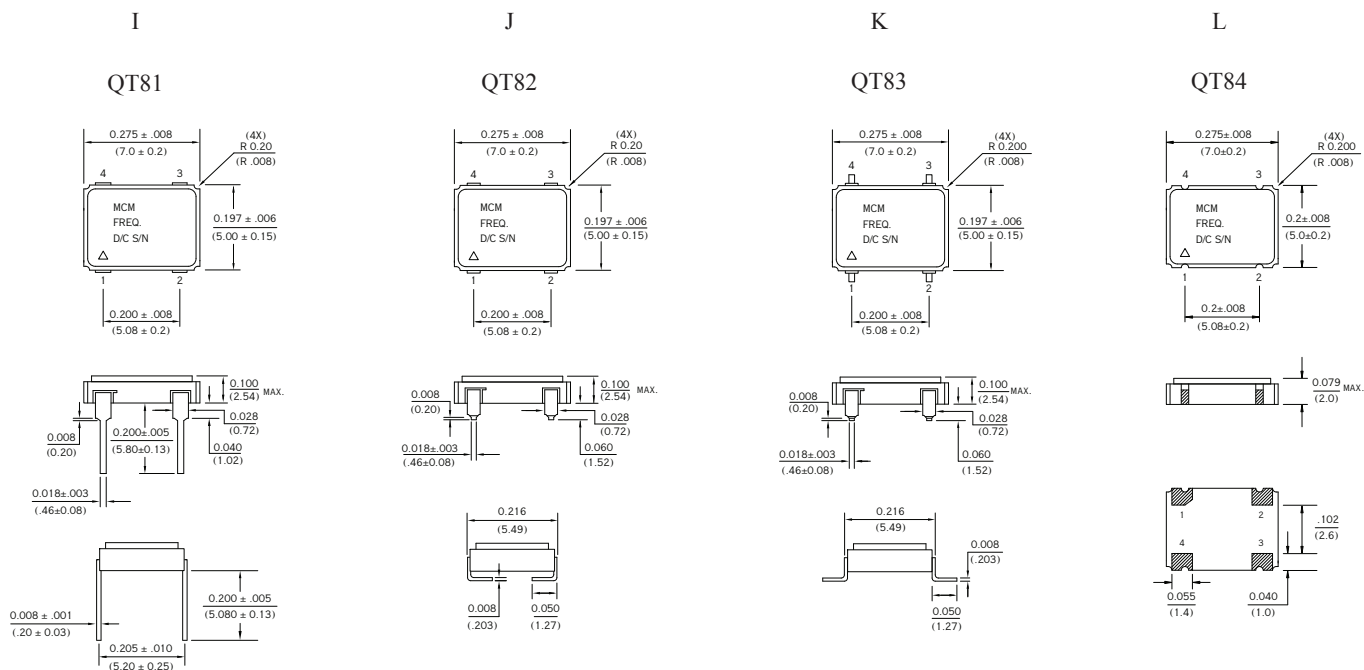

QT #	Conf	Vcc	GND	Output	E/D or N/C
QT6	A				
QT41	B	14	7	8	
QT42	C				
QT50	D	8	4	5	
QT78	E				
QT88	F	4	2	3	1
QT89	G				
QT90	H				
QT81	I				
QT82	J	4	2	3	
QT83	K				
QT84	L				
QT1	M	8	4	5	

Dimensions are in inches (mm)

Frequency vs. Temperature Curve

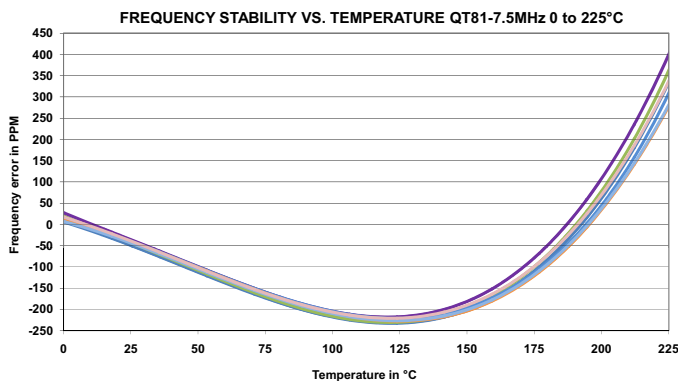
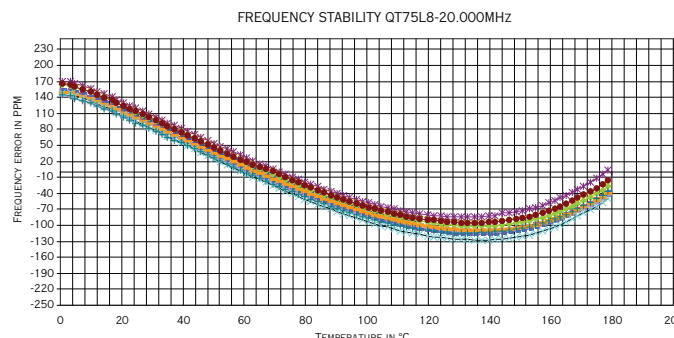
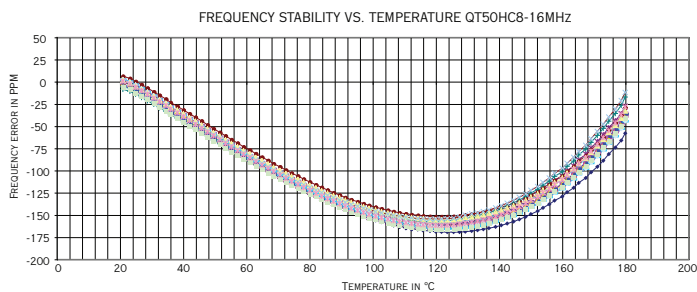
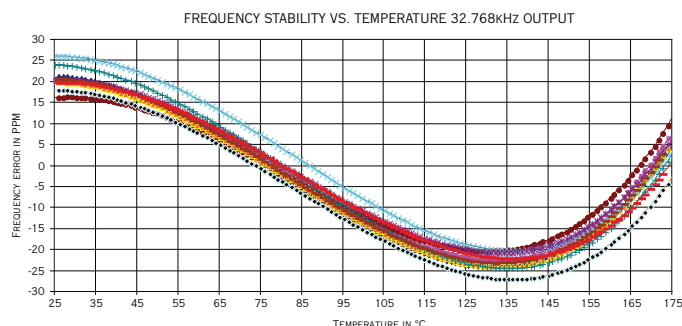

Output Waveform (Typical)

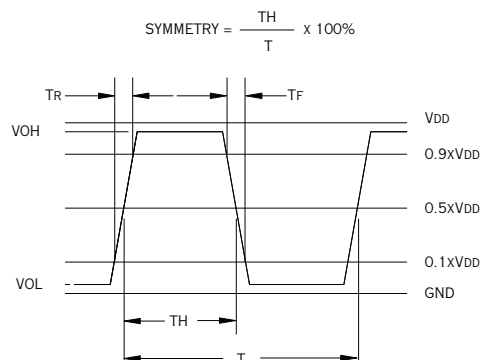

Test Circuit

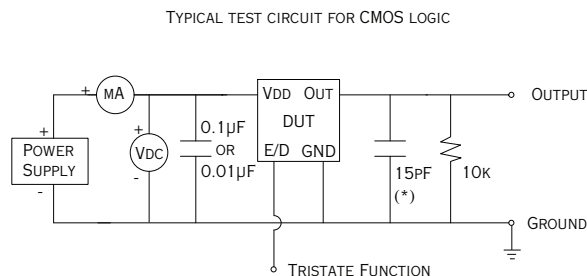

(*) CL INCLUDES PROBE AND JIG CAPACITANCE

QT50-20MHz Hi-Temp Low Current Design

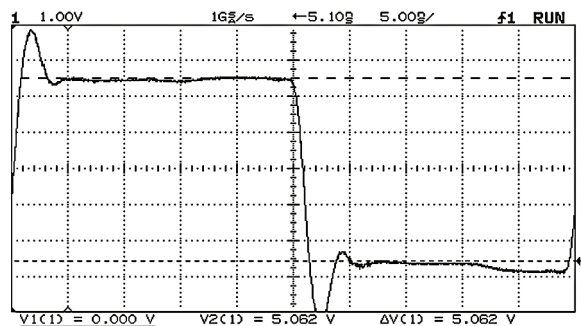

S/N	temp	I at 3.3v	I at 3.63v	I at 5.0v	I at 5.5v
1146	+25°C	1.08	1.17	1.66	1.81
1141	+25°C	1.07	1.19	1.66	1.82
1146	+200°C	1.35	1.48	2.005	2.18
1141	+200°C	1.38	1.5	2.02	2.21

Units are in mA